

Open Frame Touch Monitor

HO 165 PGB

39,6 cm / 15.6" Diagonale
LED Backlight – Format 16:9

- 1920 x 1080 Auflösung Full HD 1080P
- 10-Punkt Touch, P-Cap Technologie
- Erhöhte Helligkeit 500 cd/m² Panel
- 178° / 178° ultraweiter Betrachtungswinkel
- Eingänge: HDMI, DP, VGA
- **IP65 (vorne) Schutzart**
- **Display Schutz: Dicke 7.3 mm**
- **Betriebsdauer 24/7**
- **50.000 Stunden Backlight Lebensdauer**
- Eingebaute Stereolautsprecher
- Betriebstemperatur: -10~60°C
- Robustes Metallgehäuse
- VESA Aufnahme, weitere Montagemöglichkeiten
- Edge-to-Edge True Flat Design
- Ausrichtung: Quer, Hochformat, Face-Up

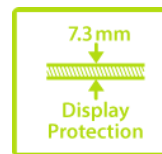
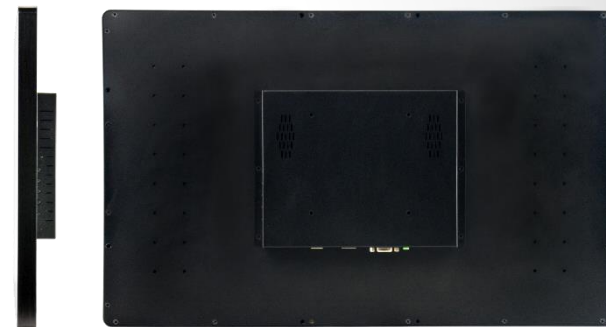

39,6 cm / 15.6"

Part. No.: HO 165 PGB

Größe, Auflösung



15.6" - 16:9
Seitenverhältnis



Full HD
1920 x 1080

Anschlüsse, IP Schutzart



VGA
HDMI
Display Port



IP 65, Wasser und
Staub Schutz

Betrachtungswinkel, VESA

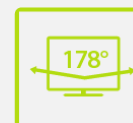

178° ultraweiter
Betrachtungswinkel



Wandmontage
VESA

Andere Eigenschaften



Betriebsdauer
24/7



Lebensdauer
50.000 Stunden

Bildschirmgröße	39,6 cm / 15.6" Diagonale
Panel Typ	TFT – LED Backlight, IPS Panel Type
Seitenverhältnis	16:9
Auflösung (H x V)	1920 x 1080 Full HD
Helligkeit (Nativ)	500 cd/m ² (Panel) – 425 cd/m ² (Monitor)
Kontrast	1000:1 (Nativ) – 10M:1 (Aktiv)
Display Bereich	345,23 x 194,54 mm
Betrachtungswinkel L/R; O/U	178° H / 178° V (CR > 10)
Reaktionszeit	25 ms
Pixelabstand	0.17925 (H) X 0.17925 (V) mm
Touch Technologie	Projected Capacitive Type – 10 Punkt Touch Material Glass + Glass Cover Glass+LOCA+ITO (Indium Tin Oxide) Glass
Bildschirmfarben	16.2M Farben
Horizontale Frequenz	31.5 ~ 80 kHz
Vertikale Frequenz	60 ~ 75 Hz
Max. Monitor Frequenz	1920 x 1080 @ 60Hz
Eingang 1	VGA
Eingang 2	HDMI
Eingang 3, 4	Display Port / USB (Touchfunktion)
Eingebaute Lautsprecher	Ja, 1,5W x 2
Energieverbrauch	An: 12,7W; Stand-by: 0,3W; Aus: 0,2W
Stromquelle	Externes Netzteil: 12 Volt / 2,5A Eingang: AC 100 ~ 240 Volt; 50 ~ 60 Hz
Produktmaße	387,3 x 236,4 x 44,3 mm (B x H x T)
Verpackungsmaße	464 x 325 x 100 mm (B x H x T)
Netto / Brutto Gewicht	3,4 Kg / 4,7 Kg

VESA Aufnahme	100 x 100 mm. Schrauben: M4 10mm (Max), Gewindesteigung 0.7 mm
Display Schutz	Dicke 7,3mm
Hartglasschutz	Härte ≥6H / ≥85%
IP Schutzart	IP 65 * (Vorne), Wasser und Staub Schutz
Bedienelemente	Menü/Ausgang, Hell.(+),Vol (-), Eingang/Enter,Power
LED Backlight Lebensdauer	50.000 Stunden
Bildschirmanzeige	8 OSD Sprachen
Farbeinstellungen	9300, 6500, 5300, User Mode
Voreinstellungen	Standard, Text, Movie, Game Modes
Betriebstemperatur	-10°~60°C
Ausrichtung	Quer, Hochformat, Face-Up
Zubehör	Netzteil mit EU und UK Kabel; HDMI Kabel (1,5m); USB 2.0 (B-A) Kabel für Touchfunktion (1,8m)

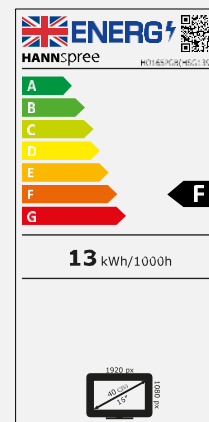
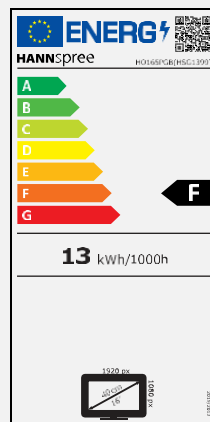

Herstellername	HANNspree
Modellname	HO165PGB
Energieeffizienzklasse für Standard Dynamic Range (SDR)	F
Energieeffizienzklasse für Standard Dynamic Range (SDR) (kWh/1000h)	13 kWh/1000h
Leistungsaufnahme im Betrieb	12,7 W
Leistungsaufnahme in ausgeschaltetem Zustand	0,2 W
Leistungsaufnahme im Standbybetrieb	0,3 W
Displaygröße (cm / Zoll)	39,6cm / 15.6"
Bildschirmauflösung	1920 x 1080

PART. NO.:
HO 165 PGB



4 711404 023040 >

* IP65: The IP Code classifies how resistant a device is to foreign objects and moisture. IP65 means that the monitor is protected from total dust ingress and it is protected against low pressure water jets from any direction. Limited ingress permitted.

HANNSpree

HO 165 PGB
15.6" Open Frame Touch Monitor

Experts in **Display**



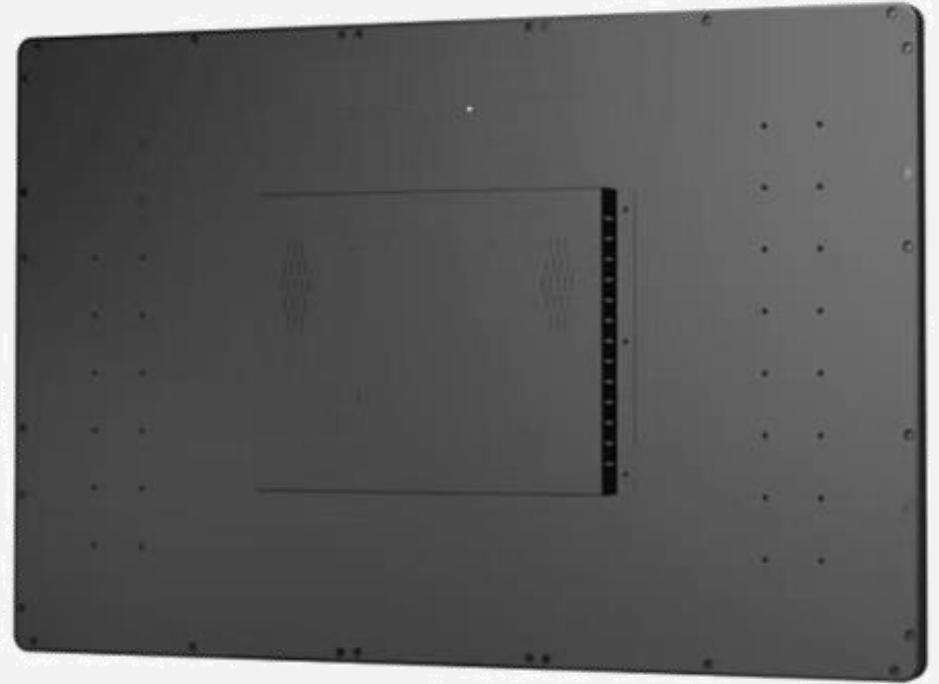
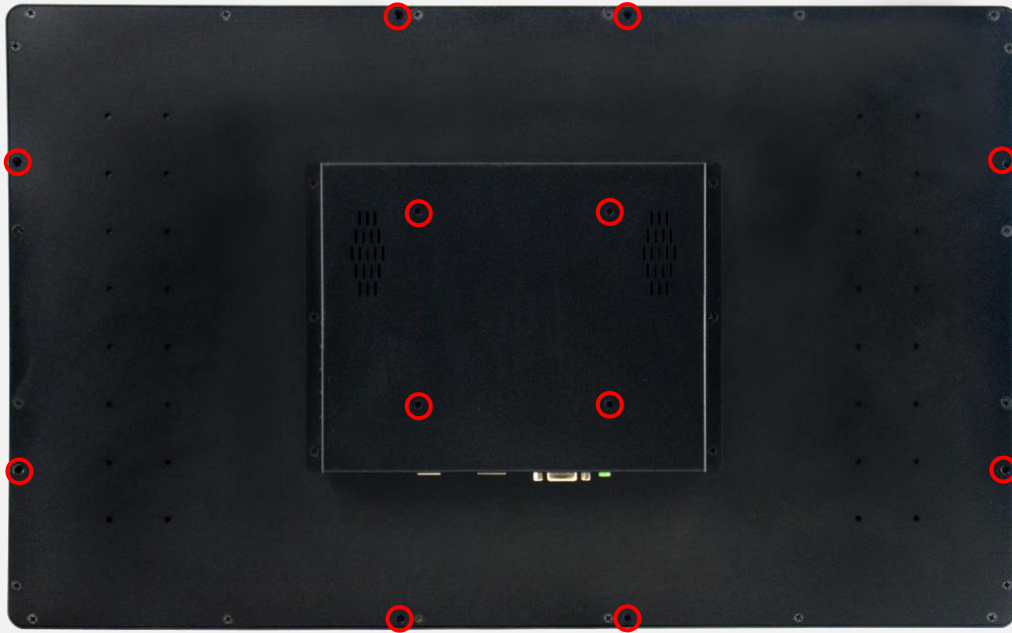

Front Cover :

Full Flat Design

Screws: M4 x 10mm (max), pitch 0.7, UNC type

HANNSpree

HO 165 PGB
15.6" Open Frame Touch Monitor

Experts in **Display**



HO 165 PGB 15.6" Open Frame Touch Monitor

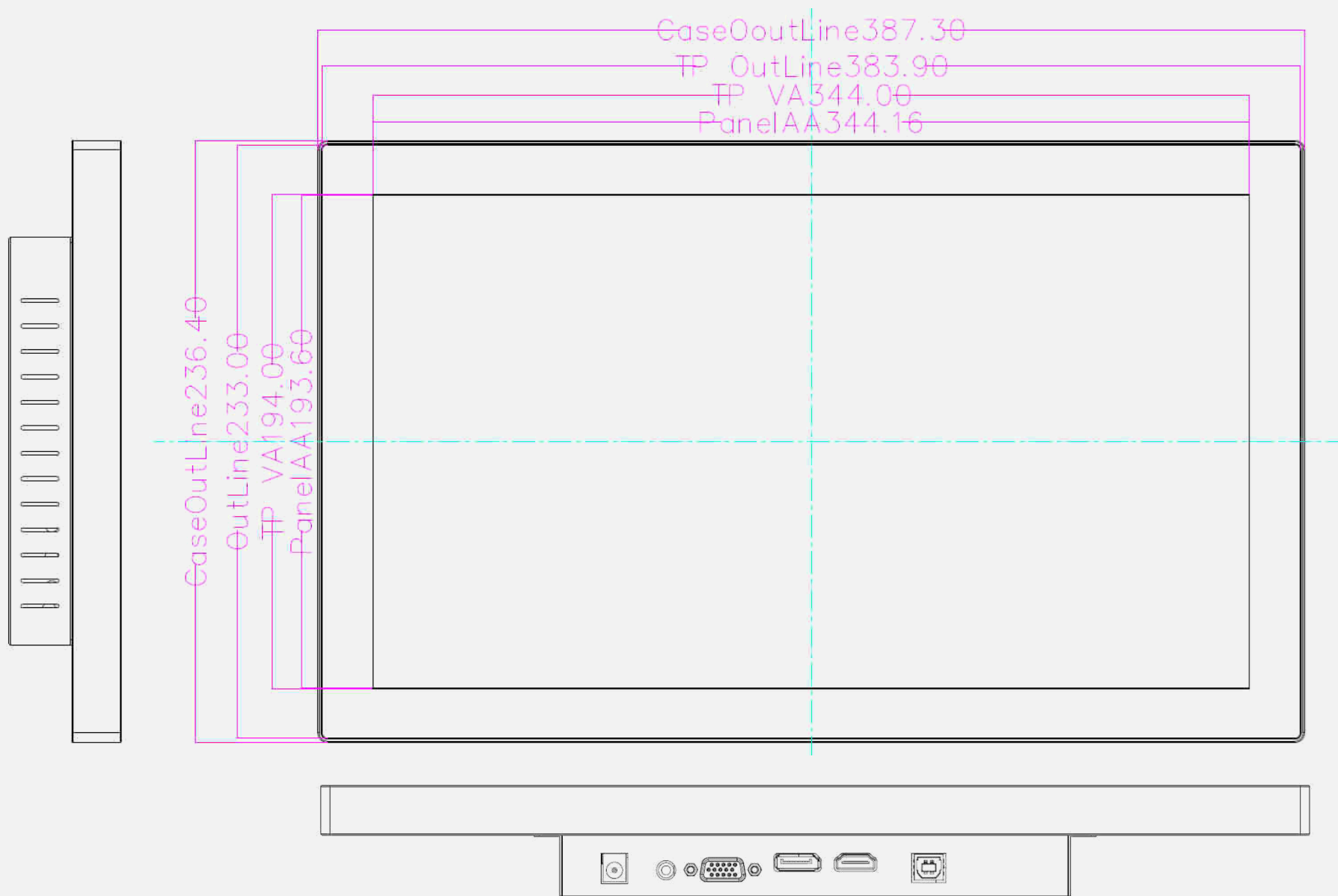

HO 165 PGB 15.6" Open Frame Touch Monitor

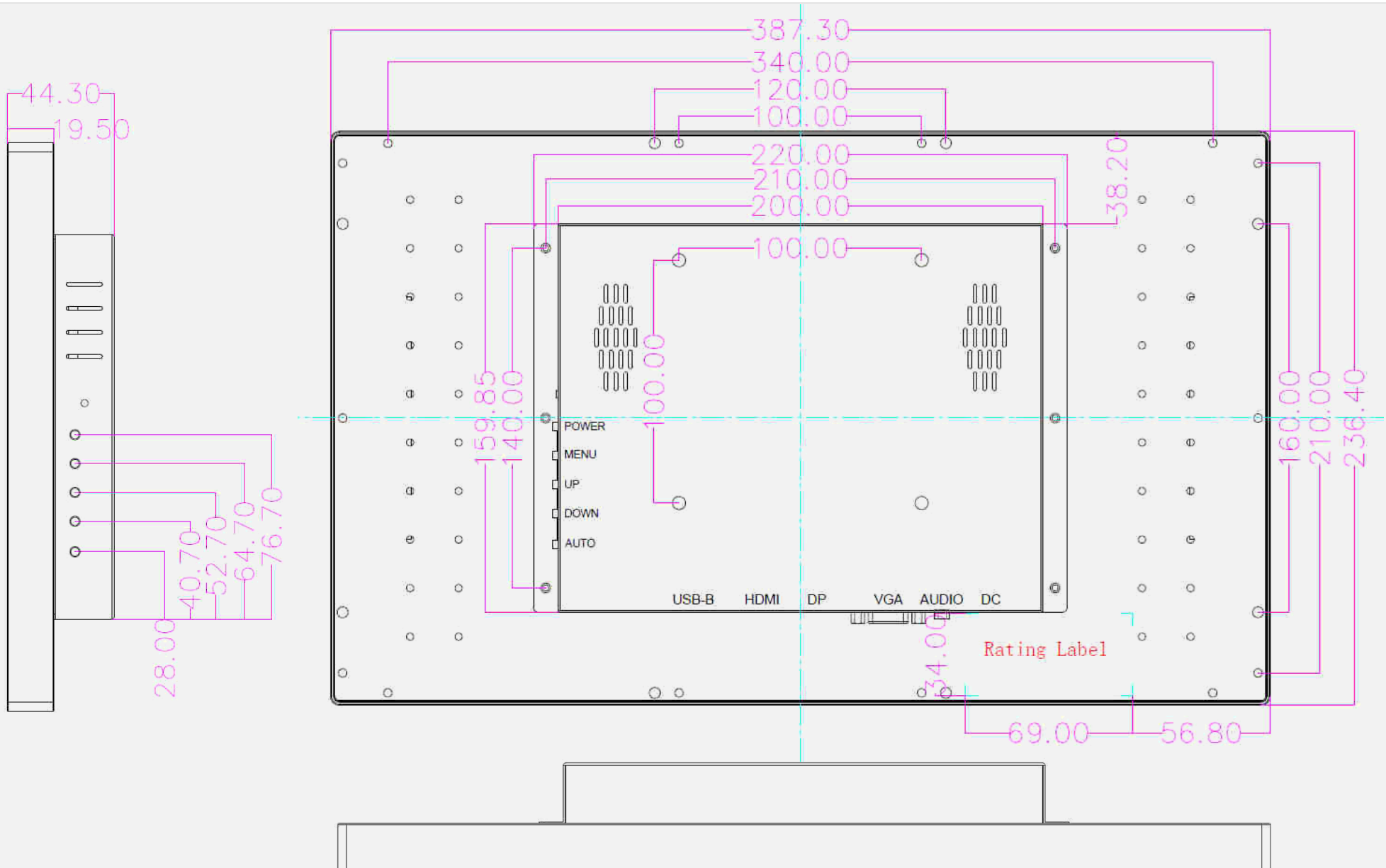

HANNspree

HO 165 PGB
15.6" Open Frame Touch Monitor

Experts in **Display**

